

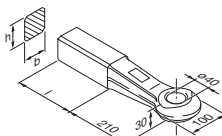





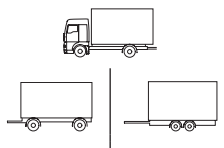

Zugösen • Towing eyes • Anneaux de remorquage • Occhioni di traino • Puntas de lanza

Form A 40 mm/50 mm mit Schweißende • Shape A 40 mm/50 mm for welding • Forme A 40 mm/50 mm avec extrémité soudée • Forma A 40 mm/50 mm con estremità saldata • Forma A 40 mm/50 mm con extremo soldado

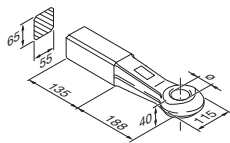
40 mm 		ø (mm)	h x b (mm)	l (mm)			S (kg)	V (kN)		ECE
					D (kN)	Dc (kN)				
ROE 57260	40	40 x 40	110	18	18	180	8	4,1	E1 55R-01 2545	
ROE 57262	40	50 x 40	110	25	25	250	9	4,7	E1 55R-01 2544	
ROE 57264	40	50 x 50	110	70	50	500	14	5,9	E1 55R-01 2543	
ROE 57268	40	65 x 55	125	125	66	900	20	7,8	E1 55R-01 2541	
ROE 57270	40	65 x 60	125	125	74	1000	23	8,2	E1 55R-01 2540	
ROE 57374	40	65 x 57	125	125	42,4	250	12	5,0	E1 55R-01 2481	
ROE 57272	50	65 x 60	170	190	90	1000	30	11,4	E1 55R-01 2561	



Form A mit Schweißende nur für Schweizer Kupplungen • Shape A for welding only for Swiss hitches • Forme A avec extrémité soudée uniquement pour crochets suisses • Forma A con estremità saldata solo per ganci svizzeri • Forma A con extremo soldado sólo para enganches suizos



	ø (mm)			S (kg)	V (kN)		ECE
		D (kN)	Dc (kN)				
ROE 57229	40	168	66	900	20,0	8,7	E1 55R-01 2562

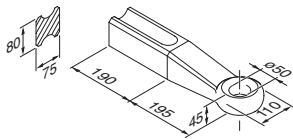

Schwerlastzugöse mit Schweißende 50 mm • Heavy duty towing eye for welding 50 mm • Anneaux de remorquage pour lourdes charges avec extrémité soudée 50 mm • Occhiono per traini eccezionali con estremità saldata 50 mm • Punta de lanza para cargas pesadas con extremo soldado 50 mm



				ECE
	D (kN)	(kg)		
ROE 57005	314	13,4	E1 55R-01 2146	

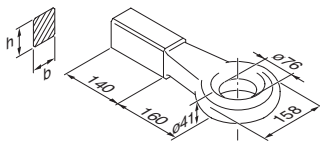

Ringzugöse mit Schweißende 76 mm VG 74059 • Ring towing eye for welding 76 mm VG 74059 • Anneaux de remorquage avec extrémité soudée 76 mm VG 74059 • Occhio torici con estremità saldata 76 mm VG 74059 • Punta de lanza anulares con extremo soldado 76 mm VG 74059



	h x b (mm)		S (kg)	C ¹ (t)		(kg)

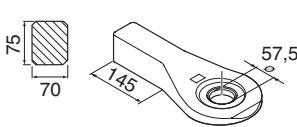

Zugöse 57,5 mm • Towing eye 57,5 mm • Anneaux de remorquage de 57,5 mm • Occhio di traino 57,5 mm • Punta de lanza 57,5 mm

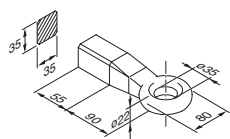

			S (kg)	V (kN)		ECE
	D (kN)	Dc (kN)				
ROE 57384	200	90	1000	30	10,0	E1 55R-01 1659

Zugöse für Flurförderzeuge mit Schweißende 35 mm DIN 8454 • Towing eye for industrial trucks for welding 35 mm DIN 8454 • Anneaux de remorquage pour chariots de manutention avec extrémité soudée 35 mm DIN 8454 • Occhio per veicoli trasporti interni con estremità saldata 35 mm DIN 8454 • Punta de lanza para vehículos industriales con extremo soldado 35 mm DIN 8454



		R (t)	S (kg)		(kg)	ECE

Schwerlastzugöse mit Schweißende 90 mm • Heavy duty towing eye for welding 90 mm • Anneaux de remorquage avec extrémité soudée 90 mm • Occhio torici con estremità saldata 90 mm • Punta de lanza anulares con extremo soldado 90 mm

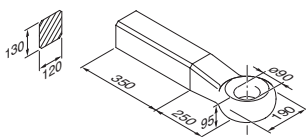



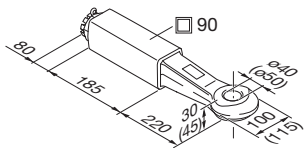

		R (t)		(kg)

Zugösen • Towing eyes • Anneaux de remorquage • Occhioni di traino • Puntas de lanza





Form B mit Schraubende • Shape B for bolting • Forme B avec extrémité vissée • Forma B con estremità a vite • Forma B con extremo atornillado

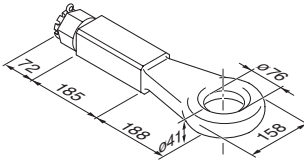

						ECE	
	ø (mm)	D (kN)	Dc (kN)	S (kg)	V (kN)	(kg)	
ROE 57318	40	125	74	1000	23,0	11,0	E1 55R-01 2563
ROE 57321	50	190	90	1000	25,0	12,6	E1 55R-01 2564





Form B mit Schraubende 76 mm nach VG 74059 • Shape B for bolting VG 74059 • Forme B avec extrémité vissée VG 74059 • Forma B con estremità a vite VG 74059 • Forma B con extremo atornillado VG 74059



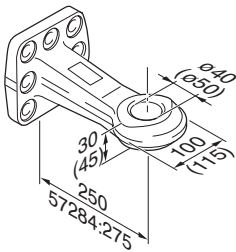

					ECE	
		D ¹ (kN)	S (kg)	C ¹ (t)	(kg)	
ROE 57294		120	1000	12	18,5	No ECE
ROE 57295		200	1500	15	18,5	No ECE

Form C/D mit Flansch • Shape C/D with flange • Forme C/D avec platine • Forma C/D con flangia • Forma C/D con brida



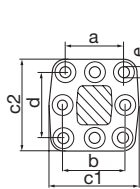





						ECE	
	ø (mm)	D (kN)	Dc (kN)	S (kg)	V (kN)	(kg)	
ROE 57243	40	130	100	1000	35,8	8,8	E1 55R-01 0046
ROE 57349	40	130	100	1000	35,8	8,8	E1 55R-01 0046
ROE 57244	50	190	135	1000	72,5	9,5	E1 55R-01 0045
ROE 57244	50	190	113	2500	43,2	9,5	E1 55R-01 0045
ROE 57284	50	250	135	1000	90,0	17,9	E1 55R-01 0162
ROE 57284	50	250	113	3000	43,2	17,9	E1 55R-01 0162

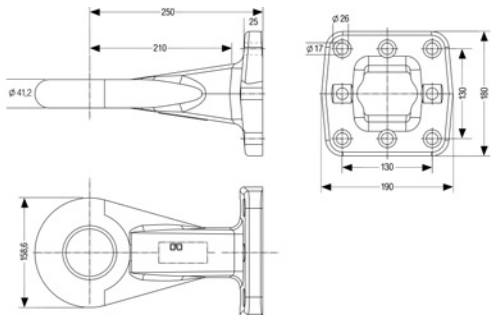

		a (mm)	b (mm)	c1 (mm)	c2 (mm)	d (mm)	e (mm)
ROE 57243		100	110	154	154	110	17,0
ROE 57349		100		154	154	110	17,0
ROE 57244		100	110	154	154	110	17,0
ROE 57284		130	130	190	180	130	21,0







Zugösen mit Flansch VG 74059 • Towing eyes with flange VG 74059 • Anneaux de remorquage avec bride VG 74059 • Occhioni di traino con flangia VG 74059 • Puntas de lanza con brida VG 74059

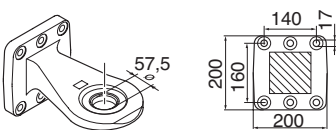

						ECE	
		D (kN)	Dc (kN)	V (kN)	S (kg)	(kg)	
ROE 57406		190	130	70	1500	23,3	E1 55R-01 2640
ROE 57406		190	130	75	1000	23,3	E1 55R-01 2640

Zugösen 57,5 mm • Towing eyes 57,5 mm • Anneaux de remorquage de 57,5 mm • Occhioni di traino 57,5 mm • Puntas de lanza 57,5 mm



							ECE	
		D (kN)	Dc (kN)	S (kg)	V (kN)	Av (t)	(kg)	
ROE 57370		300	131	1000	82	18	18,7	E1 55R-01 1356
ROE 57370		300	130	2000	50	18	18,7	E1 55R-01 1356
ROE 57370		300	146,5	1000	65,5	18	18,7	E1 55R-01 1356

